



powering **marine** safety

BUKH V8P-530

**BUKH MARINE DIESEL PERFORMANCE
V8P SERIES - 530 HP (391 KW)**

6.6 LITER DIESEL PERFORMANCE

The BUKH V8P 6.6L is a powerful and compact light weight diesel engine designed to suit all commercial and leisure applications.

With the strong Duramax base engine and marinization done by BUKH in Denmark, the BUKH V8P is the right choice when reliability, performance, and quality are some of the keywords for your project.



TECHNICAL DESCRIPTION:

ENGINE BLOCK AND HEAD

- Cast iron cylinder block - Induction hardened for increased durability
- Nitride hardened steel crankshaft
- One-piece hot forged steel connection rods
- Aluminum cylinder heads
- 4 valves per cylinder
- Front end gear train

ENGINE MOUNTING

- Flexible engine mounting

LUBRICATION SYSTEM

- Crankcase ventilation system
- External oil filter relocated in upper position for maintenance accessibility

FUEL SYSTEM

- External fuel filter installed on engine
- Fuel cooler installed on engine
- DENSO HP4 high pressure injection pump with common rail system
- DENSO G4S injection system
- Pilot injections to reduce combustion noise

AIR INLET AND EXHAUST SYSTEM

- Exhaust manifolds made of high quality cast aluminum
- Wet exhaust elbow
- Intercooled with seawater
- Intake assembly with intercooler
- Electrically controlled variable geometry turbo

COOLING SYSTEM

- Seawater cooled charge air cooler
- Heat exchanger cooled engine water
- Coolant system prepared for hot water outlet
- Easily accessible seawater pump on engine front
- Engine prepared for steering oil cooler (optional)
- Engine water level sensor (optional)
- Water in fuel sensor (optional)

ELECTRICAL SYSTEM

- 12V alternator
- Additional 24 V alternator (optional)
- Dual alternator (optional)
- Dual electric starter (optional)
- Glow plugs

INSTRUMENTS/CONTROLS

- Engine data on 3,5" display
- Laptop based diagnostics tool
- J1939 and NMEA2000 can communication
- Display IP 66 protection (front)

BUKH V8P SERIES
300-530 HP

BUKH V8P-530

BUKH MARINE DIESEL ENGINE

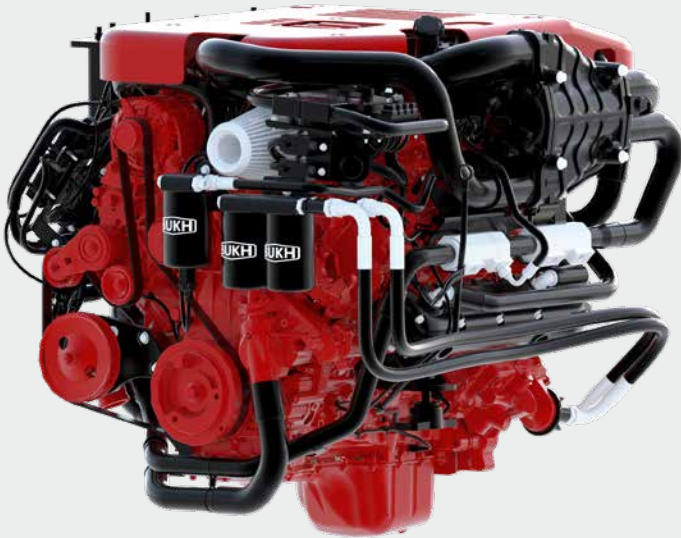

Specifications V8P-530

Engine type	V8
Engine duty rating	C10 - HSC - High speed craft
Crankshaft power [hp(kW)]	530 (391)
Rpm@full load	3000
Cylinders	V8
Displacement [L]	6,6
Bore [mm]	103
Stroke [mm]	99
Compression ratio	16.0:1
Injection system	DENSO common rail
Firing order	1-2-7-8-4-5-6-3
Electronic engine diagnostics	YES
Max. torque, NM @ 2200-2600 rpm	1220
Dry weight bobtail [kg]	578
Propulsion system	Waterjet. Shaft, stern and surface drive

mygind-co.dk

Dimensions V8P-530

Not for installation

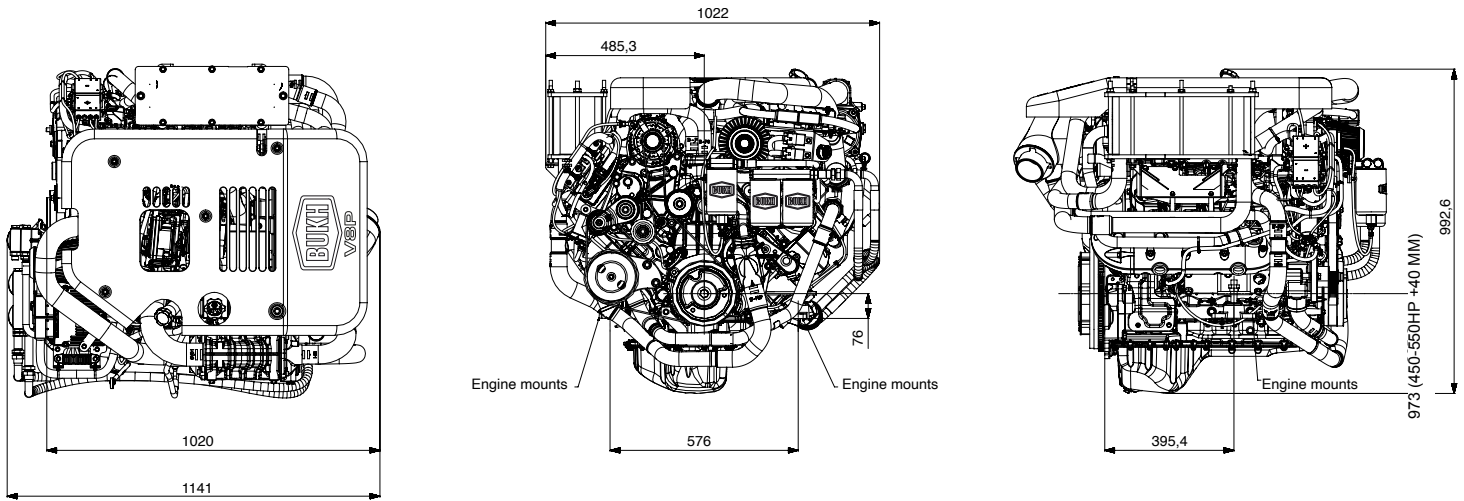

Performance Curves

